

SPECIFICATIONS TECHNIQUES CLIENT

Boite ronde S.E. Ø 108 x 105 BR

Format Ø 108 x 105

Capacité 950 ml

Dimensions (mm)

Dimensions intérieures Ø 108 x 105

Hauteur 103,70 ± 0,5

	<i>Corps</i>	<i>Fond</i>
Métal		
Type /temper	TS275	TH435
Epaisseur	0.22 mm	0.22 mm
Etamage int /ext	E 2.8 / 2.8 g/m2	D 2.8 / 5.6 g/m2
Vernis		
Intérieur	Nu	Nu
Extérieur	Nu ou impression + Vernis surimpression :Alkyde	Nu

Emballage

Dimensions palette 1420 x 1120 mm



Nbre. de boites par lit 138

Nbre. de lits 12

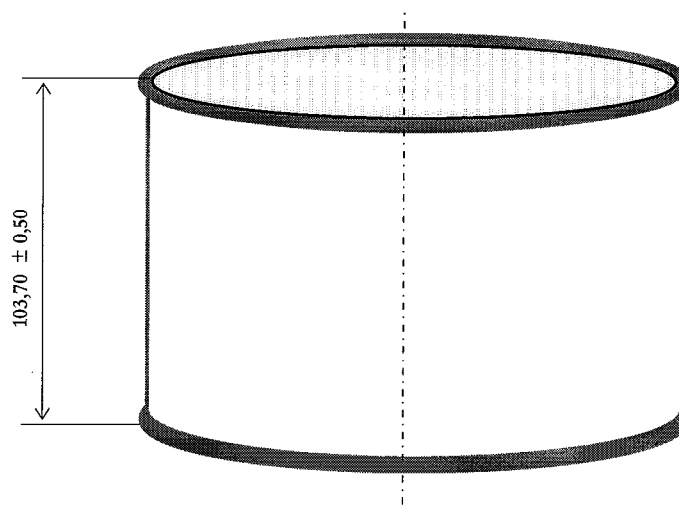
Nbre. de boites / palette 1 656

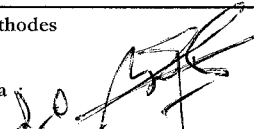

Date de mise à jour : 29 / 04 / 2008

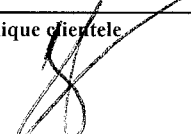
Méthodes Visa : 	Contrôle qualité Visa : 	Relation technique clientele Visa : 
---	---	---

SPECIFICATIONS TECHNIQUES CLIENT

BOUCHON " Sargiani " Ø 108

Dimensions (mm)

Dimensions intérieures	Ø 108
Profondeur de cuvette	10,5 ± 0.5
Hauteur totale	13,8 ± 0.15

Métal (Bouchon)

Type /temper	TS275
Epaisseur	0.24 mm
Etamage intérieur /extérieur	D 2.8 / 5.6 g/m2

Vernis



Intérieur	Nu
Extérieur	Couché blanc polyster

Emballage

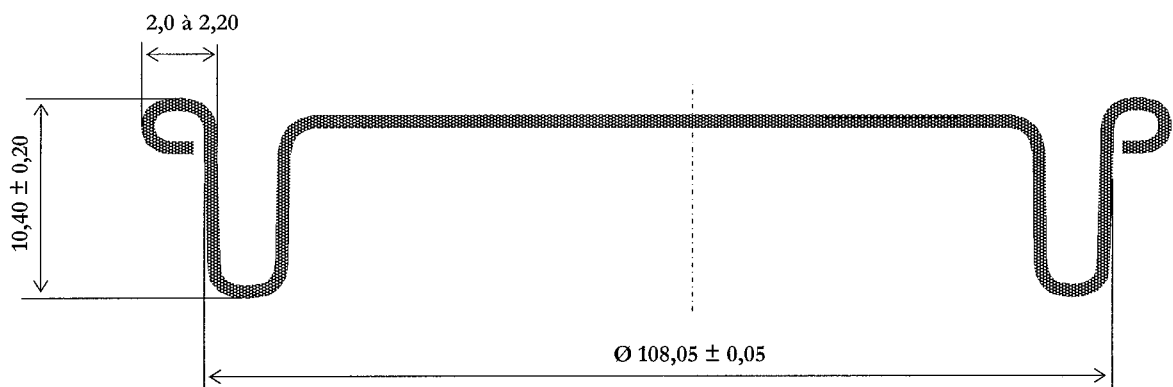
Dimensions palette	1420 x 1120 mm
Nbre. de bouchons / Pochette	65
Nbre. de pochettes / Palette :	286
Nbre. de bouchons/palette	18 590

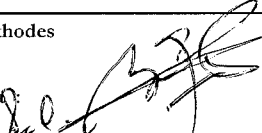

Date de mise à jour : 29 / 04 / 2008

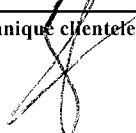
Méthodes Visa : 	Contrôle qualité Visa : 	Relation technique clientèle Visa : 
--	--	--